







Installing channel structures has never been so easy ...

-  The new channels
-  The new pipe ring saddle
-  The new pushbutton
-  The new 90° angle
-  The new 3D system
-  Example of 3D system application

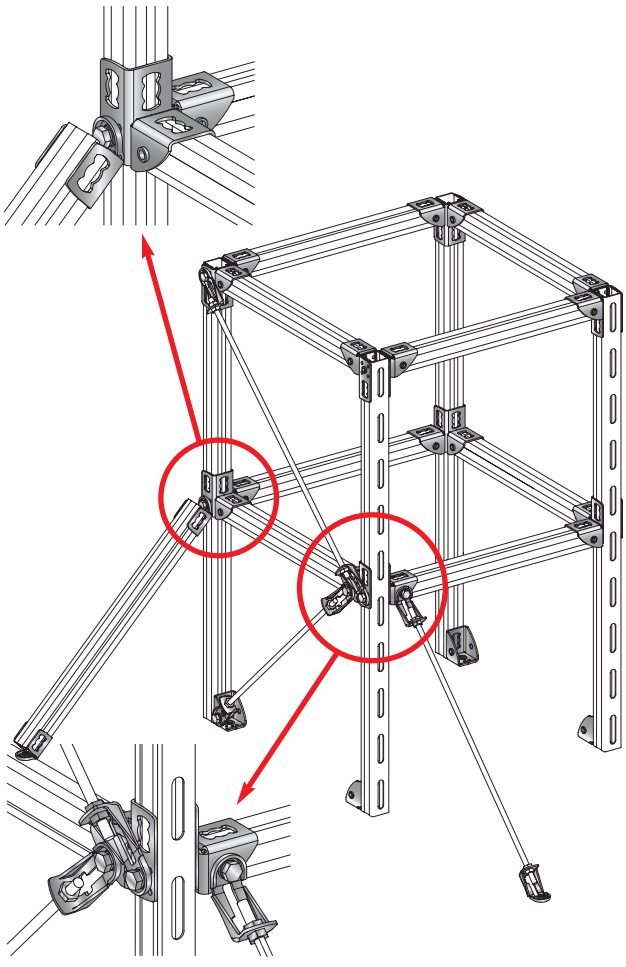

... as when using Hilti's new channel installation system.

**New pipe ring saddle and pushbutton: Fitting the quickest way**

**Revolutionary push connection:  
The new pipe ring saddle / pipe ring**

- Pipe fitting the quickest way with Hilti: MQA-Q saddle and MPH-ORC pipe ring each for push connection
- No deburring of threaded rods
- Fitting without a tool
- Height adjustment when in place
- Holding powers of pipe ring and saddle suit each other

Montage / Assembly / Montage:

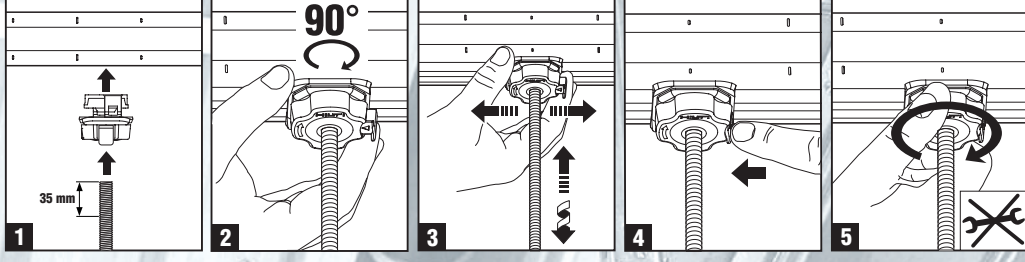

Demontage / Disassembly / Démontage:

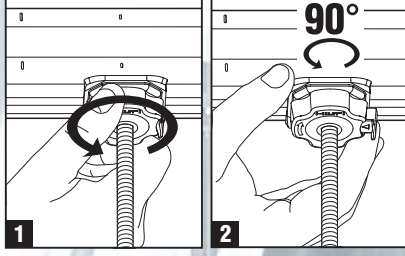

**A push-over: The new pushbutton**

- Single-part, compact pushbutton for easy use
- Fitted quickly by simply placing on and twisting into a channel
- A pushbutton for all channels increases versatility and functionality
- Removal is easy. The pushbutton can be re-used

Montage / Assembly / Montage:

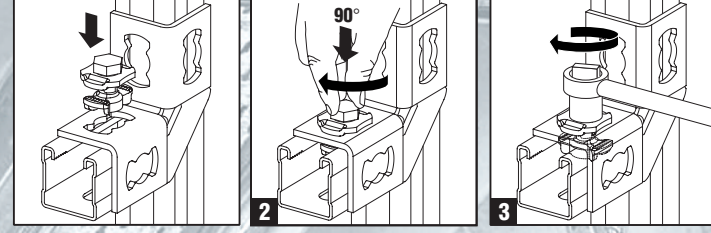

Demontage / Disassembly / Démontage:

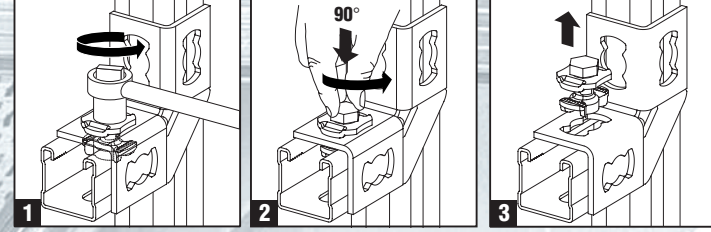

**New, quick-fitting angle and innovative 3D system: Fast and universal**

**Ingenious design:  
Pre-assembled 90° angle**

- Now, only one part instead of three
- Quicker fitting
- Clearer stocking
- Reliable keying in a channel increases the strength
- Positioning and removal are now even easier
- No parts can be lost

Montage / Assembly / Montage:

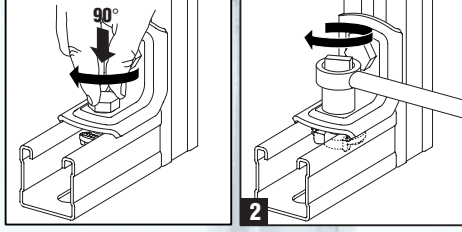

Demontage / Disassembly / Démontage:

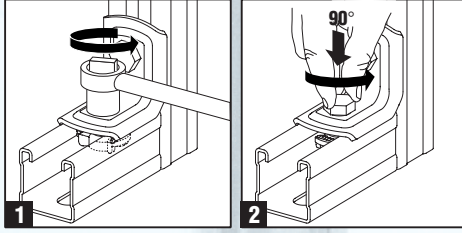

**A new dimension:  
Connectors in a 3D system**

- Only four parts for innumerable possibilities and they provide the right connector for each job
- Quick solutions due to variable assembly on the site
- Quick assembly thanks to a pre-fitted connection bolt

**Manage installation projects with intelligence.**



Hilti offers you comprehensive services from planning to maintaining installations and equipment. Simply contact our installation specialist. He will be pleased to inform you about everything we have to offer for this complex field.

- As Hilti provides complete software and product systems, you need only one supplier.
- Application solutions put together for each job ensure that you have the highest level of reliability and efficiency.
- This concept of "everything from one supplier" simplifies your ordering and stocking procedures.

**Plan meticulously:**

- Software for pipe ring, channel and fixed point design work.
- Texts for tendering.

**Draw up quotations correctly:**

- Planning support, test reports and technical data sheets.

**Prepare and execute installations perfectly:**

- System solutions, logistics concepts and supply agreements.

**Complete projects properly:**

- Well-founded documentation and required approvals.

**Maintain installations professionally:**

- Installation follow-up and support when extending existing installations.

**Efficiency from professional systems**

- A range of products that brings considerable time savings due to the high technical standard – features you should benefit from.
- Let us provide proposals for an efficient approach by your staff so that you can reduce the outlay for internal procedures.
- Did you ever have the feeling that you use oversized products? Our computer programs will help you to avoid this in future.

**Easy as child's play!**



**Hilti System MQ  
channel installation**

**The new, innovative channel  
installation system from Hilti:**

- Simple handling
- Versatile in use
- Pleasing design

# MQ Channel Installation System



Installation channel										Bracket											
MQ-21 3 m 369584/8 MQ-21 6 m 369585/5	MQ-31 3 m 369589/7 MQ-31 6 m 369590/5	MQ-41 3 m 369591/3 MQ-41 6 m 369592/1	MQ-41/3 3 m 369596/2 MQ-41/3 6 m 369597/0	MQ-52 3 m 373795/4 MQ-52 6 m 369598/8	MQ-72 3 m 373797/0 MQ-72 6 m 369599/6	MQ-21 D 3 m 369601/0 MQ-21 D 6 m 369602/8	MQ-41 D 3 m 369603/6 MQ-41 D 6 m 369604/4	MQ-52 3 m 373795/4 MQ-52 6 m 369598/8	MQ-124X D 6 m 369606/9	MQK-21/300 369607/7 MQK-21/450 369608/5	MQK-41/300 369609/3 MQK-41/450 369610/1 MQK-41/600 369611/9 MQK-41/1000 369612/7	MQK-41/3/300 370595/1 MQK-41/3/450 370596/9 MQK-41/3/600 370597/7	MQK-41/600/4 369613/5 MQK-41/1000/4 369614/3	MQK-72/450 369615/0 MQK-72/600 369616/8							
Bracket			Angle brace			Pushbutton		Channel nut		Pipe ring saddle			Angle								
MQK-21 D/300 369617/6 MQK-21 D/450 369618/4 MQK-21 D/600 369619/2	MQK-41 D/1000 369620/0	MQK-SK 369622/6 MQK-SL 369621/8	MQW-S/1 369664/8	MQW-S/2 369665/5	MQN 369623/4	MQM-M6 369624/2 MQM-M8 369698/6 MQM-M10 369626/7 MQM-M12 369627/5				MQA-M 6 369628/3 MQA-M 8 369629/1 MQA-M10 369630/9	MQA-M10 B 372471/3 MQA-M12 B 369631/7 MQA-M16 B 369632/5	MQA-1/2" 369633/3 MQA-3/4" 369634/1	MQG-2-M16 369682/0 MQG-2-1/2" 369683/8 MQG-2-3/4" 369684/6	MQW-02 369655/6	MQW-4 369658/0	MQW-8/90° 369659/8					
Angle					Connector										Base connector						
MQW-3 369656/4	MQW-P2 369661/4	MQW-8/45° 369660/6	MQW-3/45° 369657/2	MQW-2/45° 369662/2	MQW-3/135° 369663/0	MQV-2/2D 369638/2	MQV-3/2D 369640/8	MV-3/2D X 339590/2	MQV-3/3D 369641/6	MQV-4/3D 369642/4	MQV-12 369643/2	MQV-P4 369644/0	MQV-T 369645/7	MQV-2/2D-14 369639/0							
Base connector				Channel base				Beam clamp				Clamp									
MQP-1/1 369646/5	MQP-1/3 369647/3	MQP-2/3 369648/1	MQP-45° 369649/9	MQP-21-72 369651/5	MQP-82 369652/3	MQP-124 369653/1	MQP-G 369654/9	MQT-21-41 369675/4	MQT-41-82 369676/2	MQT-82-124 369677/0	MQB-21 369666/3	MQB-31 369667/1	MQB-41 369668/9	MQB-52 369669/7							
Clamp				Accessories				3D system				Pipe ring									
MQB-72 369670/5 MQB-82 369671/3	MQB-124 369672/1 MQB-4x12 369673/9	MQB-G31 373800/2 MQB-G41 369674/7	MQZ-L9 369678/8 MQZ-L11 369679/6 MQZ-L13 369680/4 MQZ-L17 369681/2	MQZ-A-M16 369687/9 MQZ-A-1/2" 369688/7 MQZ-A-3/4" 369689/5	MQZ-SV 369690/3 MQZ-SS 369691/1	MQZ-E21 370598/5 MQZ-E31 369686/1 MQZ-E41 369685/3						MQ3D-B 369694/5	MQ3D-W90° 369695/2	MQ3D-W45° 369696/0	MQ3D-A 369697/8	MP-LHI Clamping range 8 mm / 2" Connection boss M8	MPN-LI Clamping range 8 mm / 2" Connection boss M8	MPN-RC Clamping range 8 mm / 6" Connection boss M8/M10, M16			
Pipe ring				Refrigeration pipe ring				Sliding component				Fixed point									
MPN-QRC Clamping range 8 mm / 4" Connection boss for M8, M10	MP-MS Clamping range 1/2" - 224 mm Connection boss M8/M10, M10, M16	MP-MI Clamping range 3/8" - 267 mm Connection boss M10/M12, M16, 1/2", 3/4"	MP-MXI Clamping range 2" - 508 mm Connection boss M10/M12, M16, 1/2", 1"	KF Clamping range 15-609 mm Connection boss M8-M24, 1/2", 3/4"	MIP Clamping range 10-457 mm Connection boss M8/M10, M16	MRG2 roll connector 2 kN Connection boss M10/M12	MRG4 roll connector 4 kN Connection boss M10/M16	MRG-D6 roll connector 8 kN Connection boss M12/M16	MSG 1.0 1 kN Connection boss M8/M10, M12/M16	MSG 1.75 1.75 kN Connection boss M8/M10, M12/M16	KF-PP 2-6 kN	KF-PP 9-20 kN	MFP1 3 kN	MFP2 10 kN	MFP3 20 kN						